

XML Schema Documentation

Table of Contents

- [Schema Document Properties](#)
- [Global Declarations](#)
 - [Element: activeTenement](#)
 - [Element: activeTenements](#)
 - [Element: applicantsOnReceival](#)
 - [Element: area](#)
 - [Element: areaMeasurement](#)
 - [Element: block](#)
 - [Element: bond](#)
 - [Element: bonds](#)
 - [Element: centroid](#)
 - [Element: centroidDetails](#)
 - [Element: claim](#)
 - [Element: claims](#)
 - [Element: combinedReporting](#)
 - [Element: condition](#)
 - [Element: conditions](#)
 - [Element: determinationArea](#)
 - [Element: determinationAreas](#)
 - [Element: endorsements](#)
 - [Element: expenditure](#)
 - [Element: expenditures](#)
 - [Element: general](#)
 - [Element: grant](#)
 - [Element: graticularArea](#)
 - [Element: holder](#)
 - [Element: holderChanges](#)
 - [Element: holders](#)
 - [Element: latitude](#)
 - [Element: longitude](#)
 - [Element: nativeTitle](#)
 - [Element: nativeTitleDetails](#)
 - [Element: nativeTitleLineItem](#)
 - [Element: nonGraticularArea](#)
 - [Element: objection](#)
 - [Element: objections](#)
 - [Element: payments](#)
 - [Element: registerEntries](#)
 - [Element: registerEntry](#)
 - [Element: relationship](#)
 - [Element: relationships](#)
 - [Element: rentPayment](#)
 - [Element: rentPayments](#)
 - [Element: representativeAreaBodies](#)
 - [Element: representativeAreaBody](#)
 - [Element: shire](#)
 - [Element: shires](#)
 - [Element: specialIndicators](#)
 - [Element: survey](#)
 - [Element: surveys](#)
 - [Element: tenement](#)
 - [Element: tenements](#)
 - [Element: term](#)

[top](#)

Schema Document Properties

Target Namespace

<http://schema.dmp.wa.gov.au/schema/public/emits/tenementExtract/1.0>

Element and Attribute Namespaces

- Global element and attribute declarations belong to this schema's target namespace.
- By default, local element declarations belong to this schema's target namespace.

- By default, local attribute declarations have no namespace.

Declared Namespaces

Prefix	Namespace
Default namespace	http://schema.dmp.wa.gov.au/schema/public/emits/tenementExtract/1.0
xml	http://www.w3.org/XML/1998/namespace
xs	http://www.w3.org/2001/XMLSchema
xsi	http://www.w3.org/2001/XMLSchema-instance

Schema Component Representation

```
<xs:schema
  targetNamespace="http://schema.dmp.wa.gov.au/schema/public/emits/tenementExtract/1.0"
  elementFormDefault="qualified">
  ...
</xs:schema>
```

[top](#)

Global Declarations

Element: **activeTenement**

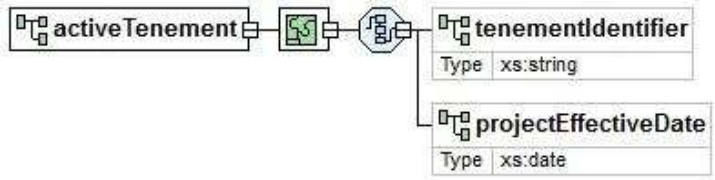
Name	activeTenement
Type	Locally-defined complex type
Niltable	no
Abstract	no
Diagram	

XML Instance Representation

```
<activeTenement>
  <tenementIdentifier> xs:string </tenementIdentifier> [0..1]
  <projectEffectiveDate> xs:date </projectEffectiveDate> [0..1]
</activeTenement>
```

Schema Component Representation

```
<xs:element name="activeTenement">
  <xs:complexType>
    <xs:sequence>
      <xs:element name="tenementIdentifier" type="xs:string" minOccurs="0"
        maxOccurs="1"/>
      <xs:element name="projectEffectiveDate" type="xs:date" minOccurs="0"
        maxOccurs="1"/>
    </xs:sequence>
  </xs:complexType>
</xs:element>
```

[top](#)

Element: **activeTenements**

Name	activeTenements
Type	Locally-defined complex type
<u>Nilable</u>	no
<u>Abstract</u>	no
Diagram	

XML Instance Representation

```
<activeTenements>
  <activeTenement> ... </activeTenement> [0..*]
</activeTenements>
```

Schema Component Representation

```
<xs:element name="activeTenements">
  <xs:complexType>
    <xs:sequence>
      <xs:element ref="activeTenement" minOccurs="0" maxOccurs="unbounded"/>
    </xs:sequence>
  </xs:complexType>
</xs:element>
```

[top](#)**Element: applicantsOnReceival**

Name	applicantsOnReceival
Type	Locally-defined complex type
<u>Nilable</u>	no
<u>Abstract</u>	no
Diagram	

XML Instance Representation

```
<applicantsOnReceival>
  <holder> ... </holder> [0..*]
</applicantsOnReceival>
```

Schema Component Representation

```
<xs:element name="applicantsOnReceival">
  <xs:complexType>
    <xs:sequence>
      <xs:element ref="holder" minOccurs="0" maxOccurs="unbounded"/>
    </xs:sequence>
  </xs:complexType>
</xs:element>
```

[top](#)**Element: area**

Name	area
Type	Locally-defined complex type
<u>Nilable</u>	no
<u>Abstract</u>	no

Diagram

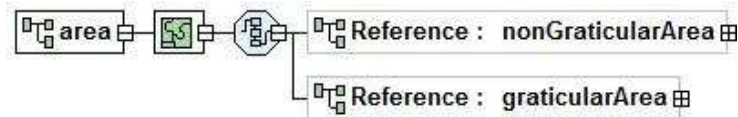

XML Instance Representation

```
<area>
  <nonGraticularArea> ... </nonGraticularArea> [0..1]
  <graticularArea> ... </graticularArea> [0..1]
</area>
```

Schema Component Representation

```
<xs:element name="area">
  <xs:complexType>
    <xs:sequence>
      <xs:element ref="nonGraticularArea" minOccurs="0" maxOccurs="1"/>
      <xs:element ref="graticularArea" minOccurs="0" maxOccurs="1"/>
    </xs:sequence>
  </xs:complexType>
</xs:element>
```

[top](#)Element: **areaMeasurement**

Name	areaMeasurement
Type	Locally-defined complex type
Nilable	no
Abstract	no
Diagram	

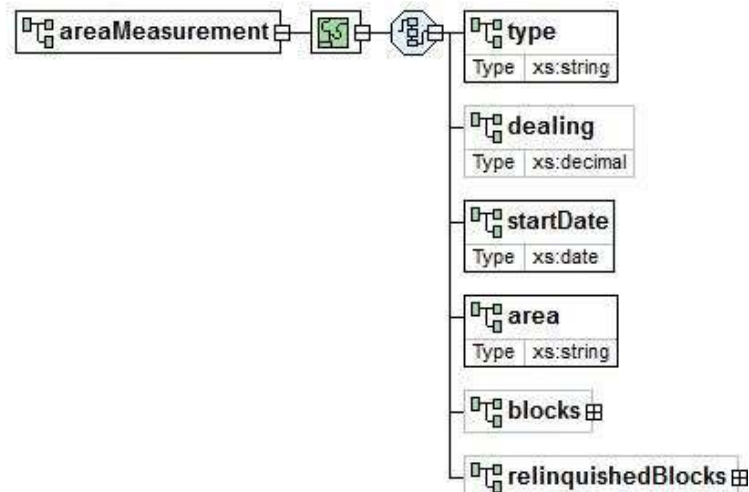

XML Instance Representation

```
<areaMeasurement>
  <type> xs:string </type> [1]
  <dealing> xs:decimal </dealing> [0..1]
  <startDate> xs:date </startDate> [1]
  <area> xs:string </area> [1]
  <blocks> [0..1]
    <block> ... </block> [0..*]
  </blocks>
  <relinquishedBlocks> [0..1]
    <block> ... </block> [0..*]
  </relinquishedBlocks>
</areaMeasurement>
```

Schema Component Representation

```

<xs:element name="areaMeasurement">
  <xs:complexType>
    <xs:sequence>
      <xs:element name="type" type="xs:string" minOccurs="1" maxOccurs="1"/>
      <xs:element name="dealing" type="xs:decimal" minOccurs="0"
maxOccurs="1"/>
      <xs:element name="startDate" type="xs:date" minOccurs="1"
maxOccurs="1"/>
      <xs:element name="area" type="xs:string" minOccurs="1" maxOccurs="1"/>
      <!-- this is for graticular only -->
      <xs:element name="blocks" minOccurs="0" maxOccurs="1">
        <xs:complexType>
          <xs:sequence>
            <xs:element ref="block" minOccurs="0" maxOccurs="unbounded"/>
          </xs:sequence>
        </xs:complexType>
      </xs:element>
      <xs:element name="relinquishedBlocks" minOccurs="0" maxOccurs="1">
        <xs:complexType>
          <xs:sequence>
            <xs:element ref="block" minOccurs="0" maxOccurs="unbounded"/>
          </xs:sequence>
        </xs:complexType>
      </xs:element>
    </xs:sequence>
  </xs:complexType>
</xs:element>

```

[top](#)

Element: **block**

Name	block
Type	Locally-defined complex type
<u>Nilable</u>	no
<u>Abstract</u>	no
Diagram	

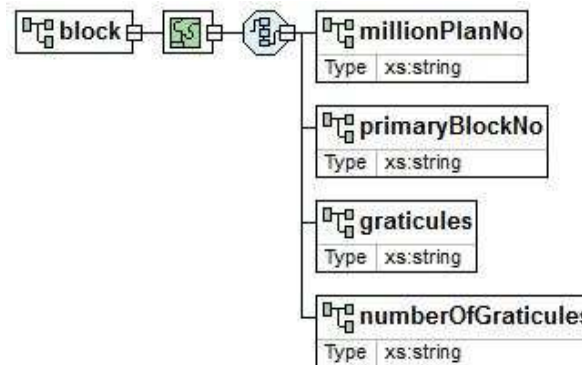

XML Instance Representation

```

<block>
  <millionPlanNo> xs:string </millionPlanNo> [1]
  <primaryBlockNo> xs:string </primaryBlockNo> [1]
  <graticules> xs:string </graticules> [1]
  <numberOfGraticules> xs:string </numberOfGraticules> [1]
</block>

```

Schema Component Representation

```

<xs:element name="block">
  <xs:complexType>

```

```

<xs:sequence>
  <xs:element name="millionPlanNo" type="xs:string" minOccurs="1"
    maxOccurs="1"/>
  <xs:element name="primaryBlockNo" type="xs:string" minOccurs="1"
    maxOccurs="1"/>
  <xs:element name="graticules" type="xs:string" minOccurs="1"
    maxOccurs="1"/>
  <xs:element name="numberOfGraticules" type="xs:string" minOccurs="1"
    maxOccurs="1"/>
</xs:sequence>
</xs:complexType>
</xs:element>

```

[top](#)**Element: bond**

Name	bond
Type	Locally-defined complex type
Niltable	no
Abstract	no
Diagram	

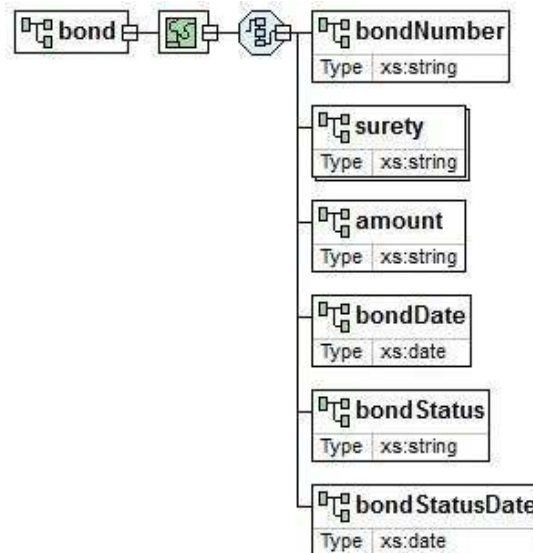
**XML Instance Representation**

```

<bond>
  <bondNumber> xs:string </bondNumber> [1]
  <surety> xs:string </surety> [1..*]
  <amount> xs:string </amount> [1]
  <bondDate> xs:date </bondDate> [1]
  <bondStatus> xs:string </bondStatus> [1]
  <bondStatusDate> xs:date </bondStatusDate> [1]
</bond>

```

Schema Component Representation

```

<xs:element name="bond">
  <xs:complexType>
    <xs:sequence>
      <xs:element name="bondNumber" type="xs:string" minOccurs="1"
        maxOccurs="1"/>
      <xs:element name="surety" type="xs:string" minOccurs="1"
        maxOccurs="unbounded"/>
      <xs:element name="amount" type="xs:string" minOccurs="1"
        maxOccurs="1"/>
      <xs:element name="bondDate" type="xs:date" minOccurs="1"

```

```

maxOccurs="1"/>
<xs:element name="bondStatus" type="xs:string" minOccurs="1"
maxOccurs="1"/>
<xs:element name="bondStatusDate" type="xs:date" minOccurs="1"
maxOccurs="1"/>
</xs:sequence>
</xs:complexType>
</xs:element>

```

[top](#)**Element: bonds**

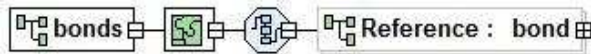
Name	bonds
Type	Locally-defined complex type
Nilable	no
Abstract	no
Diagram	

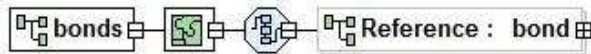
**XML Instance Representation**

```

<bonds>
  <bond> ... </bond> [0..*]
</bonds>

```

Schema Component Representation

```

<xs:element name="bonds">
  <xs:complexType>
    <xs:sequence>
      <xs:element ref="bond" minOccurs="0" maxOccurs="unbounded"/>
    </xs:sequence>
  </xs:complexType>
</xs:element>

```

[top](#)**Element: centroid**

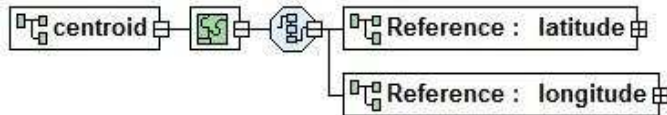
Name	centroid
Type	Locally-defined complex type
Nilable	no
Abstract	no
Diagram	

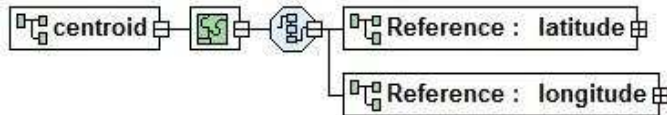
**XML Instance Representation**

```

<centroid>
  <latitude> ... </latitude> [1]
  <longitude> ... </longitude> [1]
</centroid>

```

Schema Component Representation

```

<xs:element name="centroid">
  <xs:complexType>

```

```

<xs:sequence>
  <xs:element ref="latitude" minOccurs="1" maxOccurs="1"/>
  <xs:element ref="longitude" minOccurs="1" maxOccurs="1"/>
</xs:sequence>
</xs:complexType>
</xs:element>

```

[top](#)**Element: centroidDetails**

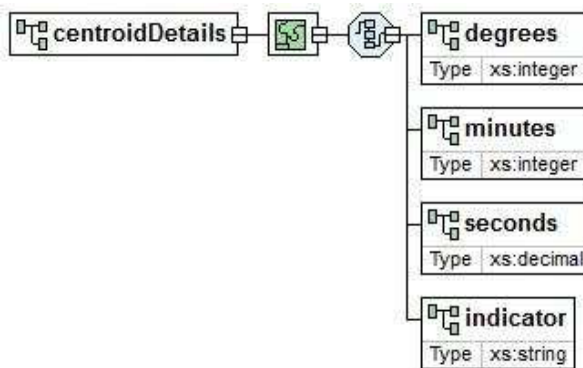
Name	centroidDetails
Type	Locally-defined complex type
Niltable	no
Abstract	no
Diagram	

XML Instance Representation

```

<centroidDetails>
  <degrees> xs:integer </degrees> [1]
  <minutes> xs:integer </minutes> [1]
  <seconds> xs:decimal </seconds> [1]
  <indicator> xs:string </indicator> [1]
</centroidDetails>

```

Schema Component Representation

```

<xs:element name="centroidDetails">
  <xs:complexType>
    <xs:sequence>
      <xs:element name="degrees" type="xs:integer" minOccurs="1"
        maxOccurs="1"/>
      <xs:element name="minutes" type="xs:integer" minOccurs="1"
        maxOccurs="1"/>
      <xs:element name="seconds" type="xs:decimal" minOccurs="1"
        maxOccurs="1"/>
      <xs:element name="indicator" type="xs:string" minOccurs="1"
        maxOccurs="1"/>
    </xs:sequence>
  </xs:complexType>
</xs:element>

```

[top](#)**Element: claim**

Name	claim
Type	Locally-defined complex type

<u>Nilable</u>	no
<u>Abstract</u>	no
Diagram	

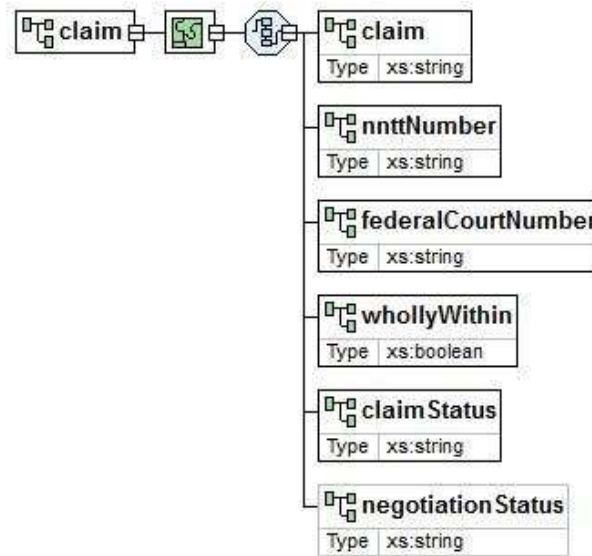

XML Instance Representation

```

<claim>
  <claim> xs:string </claim> [1]
  <nnttNumber> xs:string </nnttNumber> [1]
  <federalCourtNumber> xs:string </federalCourtNumber> [1]
  <whollyWithin> xs:boolean </whollyWithin> [1]
  <claimStatus> xs:string </claimStatus> [1]
  <negotiationStatus> xs:string </negotiationStatus> [0..1]
</claim>
  
```

Schema Component Representation

```

<xs:element name="claim">
  <xs:complexType>
    <xs:sequence>
      <xs:element name="claim" type="xs:string" minOccurs="1"
        maxOccurs="1"/>
      <xs:element name="nnttNumber" type="xs:string" minOccurs="1"
        maxOccurs="1"/>
      <xs:element name="federalCourtNumber" type="xs:string" minOccurs="1"
        maxOccurs="1"/>
      <xs:element name="whollyWithin" type="xs:boolean" minOccurs="1"
        maxOccurs="1"/>
      <xs:element name="claimStatus" type="xs:string" minOccurs="1"
        maxOccurs="1"/>
      <xs:element name="negotiationStatus" type="xs:string" minOccurs="0"
        maxOccurs="1"/>
    </xs:sequence>
  </xs:complexType>
</xs:element>
  
```

[top](#)

Element: **claims**

Name	claims
Type	Locally-defined complex type
<u>Nilable</u>	no
<u>Abstract</u>	no

Diagram

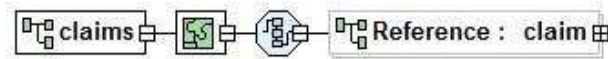

XML Instance Representation

```
<claims>
  <claim> ... </claim> [0..*]
</claims>
```

Schema Component Representation

```
<xs:element name="claims">
  <xs:complexType>
    <xs:sequence>
      <xs:element ref="claim" minOccurs="0" maxOccurs="unbounded"/>
    </xs:sequence>
  </xs:complexType>
</xs:element>
```

[top](#)Element: **combinedReporting**

Name	combinedReporting
Type	Locally-defined complex type
Niltable	no
Abstract	no
Diagram	

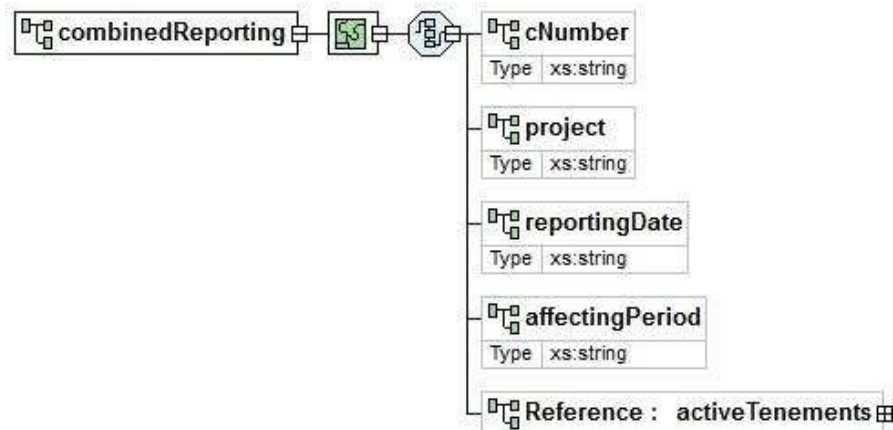

XML Instance Representation

```
<combinedReporting>
  <cNumber> xs:string </cNumber> [0..1]
  <project> xs:string </project> [0..1]
  <reportingDate> xs:string </reportingDate> [0..1]
  <affectingPeriod> xs:string </affectingPeriod> [0..1]
  <activeTenements> ... </activeTenements> [0..1]
</combinedReporting>
```

Schema Component Representation

```
<xs:element name="combinedReporting">
  <xs:complexType>
    <xs:sequence>
      <xs:element name="cNumber" type="xs:string" minOccurs="0"
        maxOccurs="1"/>
      <xs:element name="project" type="xs:string" minOccurs="0"
        maxOccurs="1"/>
      <xs:element name="reportingDate" type="xs:string" minOccurs="0"
        maxOccurs="1"/>
    </xs:sequence>
  </xs:complexType>
</xs:element>
```

```

    <xs:element name="affectingPeriod" type="xs:string" minOccurs="0"
      maxOccurs="1"/>
    <xs:element ref="activeTenements" minOccurs="0" maxOccurs="1"/>
  </xs:sequence>
</xs:complexType>
</xs:element>

```

[top](#)**Element: condition**

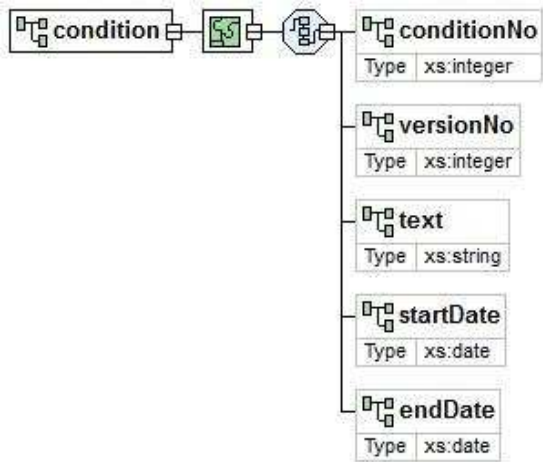
Name	condition
Type	Locally-defined complex type
Niltable	no
Abstract	no
Diagram	

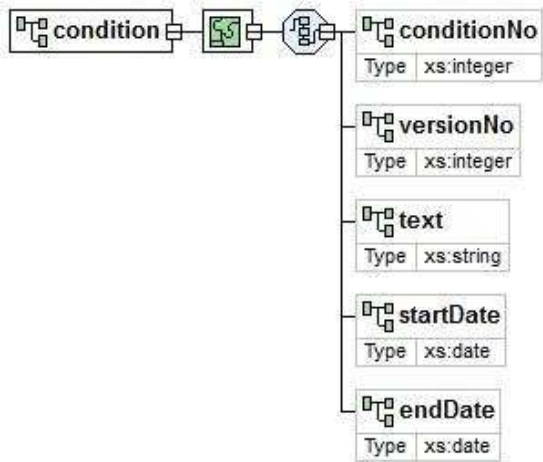
**XML Instance Representation**

```

<condition>
  <conditionNo> xs:integer </conditionNo> [0..1]
  <versionNo> xs:integer </versionNo> [0..1]
  <text> xs:string </text> [0..1]
  <startDate> xs:date </startDate> [0..1]
  <endDate> xs:date </endDate> [0..1]
</condition>

```

Schema Component Representation

```

<xs:element name="condition">
  <xs:complexType>
    <xs:sequence>
      <xs:element name="conditionNo" type="xs:integer" minOccurs="0"
        maxOccurs="1"/>
      <xs:element name="versionNo" type="xs:integer" minOccurs="0"
        maxOccurs="1"/>
      <xs:element name="text" type="xs:string" minOccurs="0" maxOccurs="1"/>
      <xs:element name="startDate" type="xs:date" minOccurs="0"
        maxOccurs="1"/>
      <xs:element name="endDate" type="xs:date" minOccurs="0"
        maxOccurs="1"/>
    </xs:sequence>
  </xs:complexType>
</xs:element>

```

[top](#)

Element: conditions

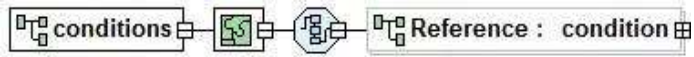
Name	conditions
Type	Locally-defined complex type
<u>Nilable</u>	no
<u>Abstract</u>	no
Diagram	

XML Instance Representation

```
<conditions>
  <condition> ... </condition> [0..*]
</conditions>
```

Schema Component Representation

```
<xs:element name="conditions">
  <xs:complexType>
    <xs:sequence>
      <xs:element ref="condition" minOccurs="0" maxOccurs="unbounded"/>
    </xs:sequence>
  </xs:complexType>
</xs:element>
```

[top](#)**Element: determinationArea**

Name	determinationArea
Type	Locally-defined complex type
<u>Nilable</u>	no
<u>Abstract</u>	no
Diagram	

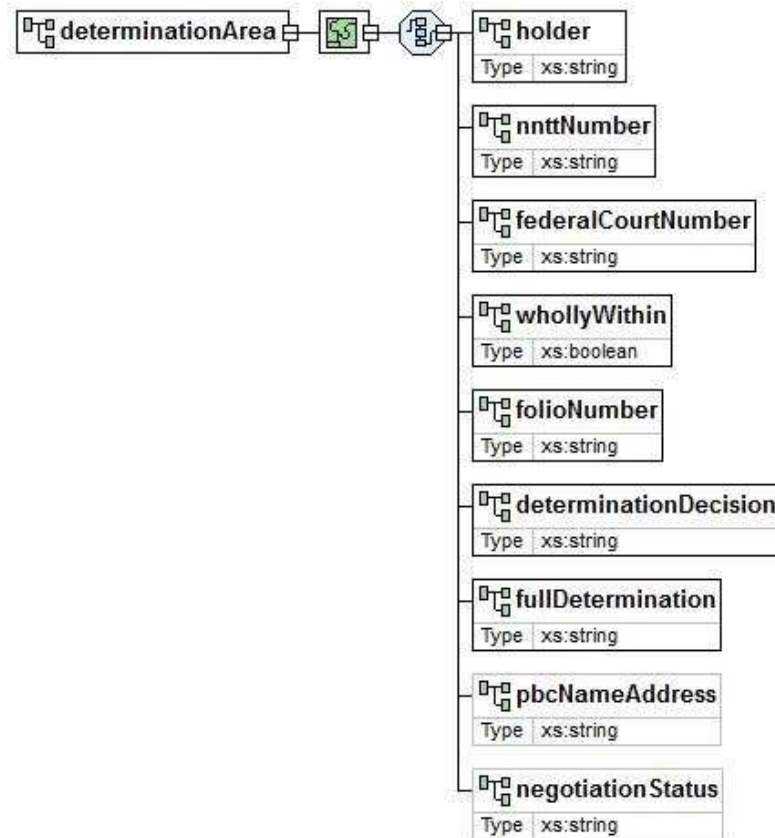

XML Instance Representation

```

<determinationArea>
  <holder> xs:string </holder> [1]
  <nnttNumber> xs:string </nnttNumber> [1]
  <federalCourtNumber> xs:string </federalCourtNumber> [1]
  <whollyWithin> xs:boolean </whollyWithin> [1]
  <folioNumber> xs:string </folioNumber> [1]
  <determinationDecision> xs:string </determinationDecision> [1]
  <fullDetermination> xs:string </fullDetermination> [1]
  <pbcNameAddress> xs:string </pbcNameAddress> [0..1]
  <negotiationStatus> xs:string </negotiationStatus> [0..1]
</determinationArea>

```

Schema Component Representation

```

<xs:element name="determinationArea">
  <xs:complexType>
    <xs:sequence>
      <xs:element name="holder" type="xs:string" minOccurs="1"
maxOccurs="1"/>
      <xs:element name="nnttNumber" type="xs:string" minOccurs="1"
maxOccurs="1"/>
      <xs:element name="federalCourtNumber" type="xs:string" minOccurs="1"
maxOccurs="1"/>
      <xs:element name="whollyWithin" type="xs:boolean" minOccurs="1"
maxOccurs="1"/>
      <xs:element name="folioNumber" type="xs:string" minOccurs="1"
maxOccurs="1"/>
      <xs:element name="determinationDecision" type="xs:string"
minOccurs="1" maxOccurs="1"/>
      <xs:element name="fullDetermination" type="xs:string" minOccurs="1"
maxOccurs="1"/>
      <xs:element name="pbcNameAddress" type="xs:string" minOccurs="0"
maxOccurs="1"/>
      <xs:element name="negotiationStatus" type="xs:string" minOccurs="0"
maxOccurs="1"/>
    </xs:sequence>
  </xs:complexType>
</xs:element>

```

```

</xs:complexType>
</xs:element>

```

[top](#)**Element: `determinationAreas`**

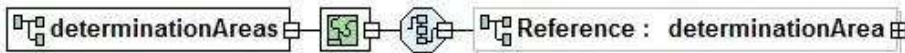
Name	determinationAreas
Type	Locally-defined complex type
Nilable	no
Abstract	no
Diagram	

XML Instance Representation

```

<determinationAreas>
  <determinationArea> ... </determinationArea> [0..*]
</determinationAreas>

```

Schema Component Representation

```

<xs:element name="determinationAreas">
  <xs:complexType>
    <xs:sequence>
      <xs:element ref="determinationArea" minOccurs="0"
        maxOccurs="unbounded"/>
    </xs:sequence>
  </xs:complexType>
</xs:element>

```

[top](#)**Element: `endorsements`**

Name	endorsements
Type	Locally-defined complex type
Nilable	no
Abstract	no
Diagram	

XML Instance Representation

```

<endorsements>
  <condition> ... </condition> [0..*]
</endorsements>

```

Schema Component Representation

```

<xs:element name="endorsements">
  <xs:complexType>
    <xs:sequence>
      <xs:element ref="condition" minOccurs="0"
        maxOccurs="unbounded"/>
    </xs:sequence>
  </xs:complexType>
</xs:element>

```

[top](#)

Element: expenditure

Name	expenditure
Type	Locally-defined complex type
Nilable	no
Abstract	no
Diagram	

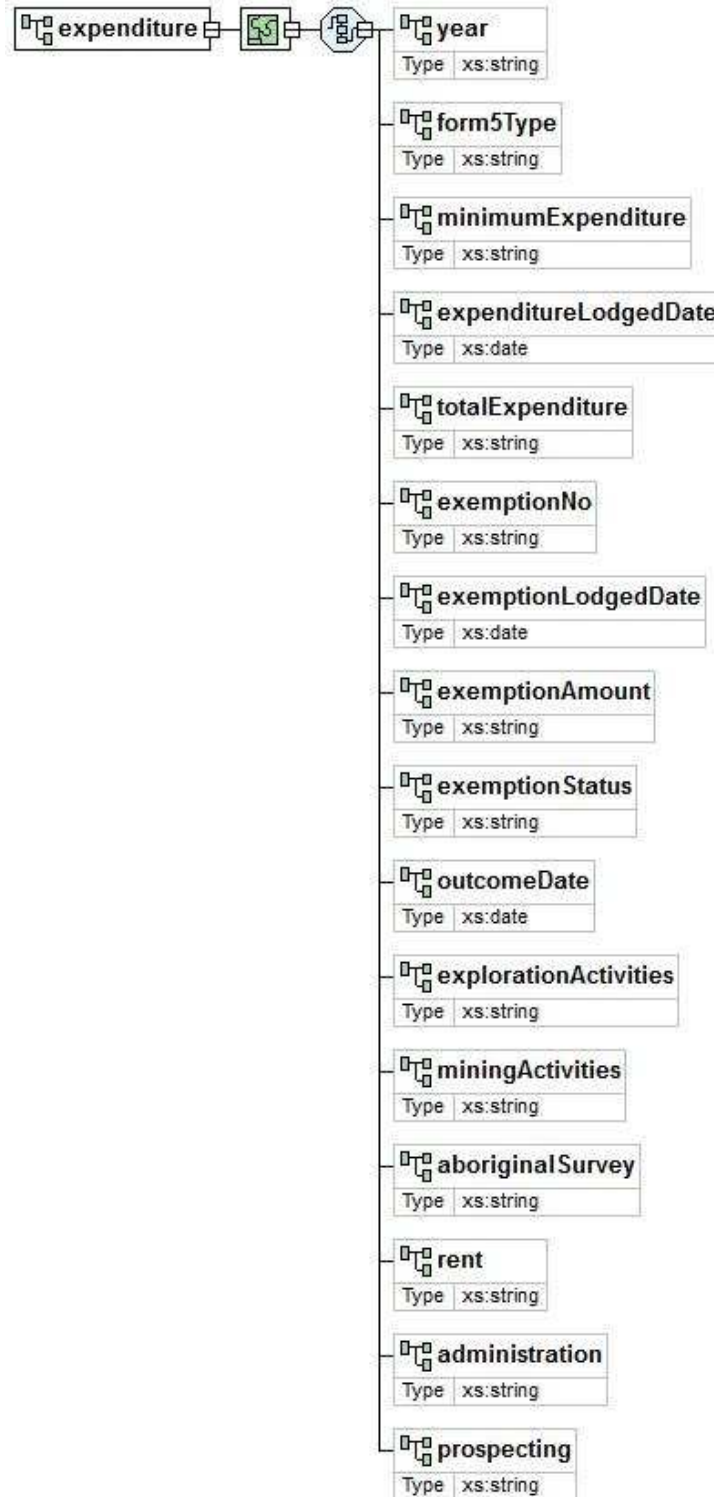
**XML Instance Representation**

```

<expenditure>
  <year> xs:string </year> [0..1]
  <form5Type> xs:string </form5Type> [0..1]
  <minimumExpenditure> xs:string </minimumExpenditure> [0..1]

```

```

<expenditureLodgedDate> xs:date </expenditureLodgedDate> [0..1]
<totalExpenditure> xs:string </totalExpenditure> [0..1]
<exemptionNo> xs:string </exemptionNo> [0..1]
<exemptionLodgedDate> xs:date </exemptionLodgedDate> [0..1]
<exemptionAmount> xs:string </exemptionAmount> [0..1]
<exemptionStatus> xs:string </exemptionStatus> [0..1]
<outcomeDate> xs:date </outcomeDate> [0..1]
<explorationActivities> xs:string </explorationActivities> [0..1]
<miningActivities> xs:string </miningActivities> [0..1]
<aboriginalSurvey> xs:string </aboriginalSurvey> [0..1]
<rent> xs:string </rent> [0..1]
<administration> xs:string </administration> [0..1]
<prospecting> xs:string </prospecting> [0..1]
</expenditure>

```

Schema Component Representation

```

<xs:element name="expenditure">
  <xs:complexType>
    <xs:sequence>
      <xs:element name="year" type="xs:string" minOccurs="0" maxOccurs="1"/>
      <xs:element name="form5Type" type="xs:string" minOccurs="0"
maxOccurs="1"/>
      <xs:element name="minimumExpenditure" type="xs:string" minOccurs="0"
maxOccurs="1"/>
      <xs:element name="expenditureLodgedDate" type="xs:date" minOccurs="0"
maxOccurs="1"/>
      <xs:element name="totalExpenditure" type="xs:string" minOccurs="0"
maxOccurs="1"/>
      <xs:element name="exemptionNo" type="xs:string" minOccurs="0"
maxOccurs="1"/>
      <xs:element name="exemptionLodgedDate" type="xs:date" minOccurs="0"
maxOccurs="1"/>
      <xs:element name="exemptionAmount" type="xs:string" minOccurs="0"
maxOccurs="1"/>
      <xs:element name="exemptionStatus" type="xs:string" minOccurs="0"
maxOccurs="1"/>
      <xs:element name="outcomeDate" type="xs:date" minOccurs="0"
maxOccurs="1"/>
      <xs:element name="explorationActivities" type="xs:string"
minOccurs="0" maxOccurs="1"/>
      <xs:element name="miningActivities" type="xs:string" minOccurs="0"
maxOccurs="1"/>
      <xs:element name="aboriginalSurvey" type="xs:string" minOccurs="0"
maxOccurs="1"/>
      <xs:element name="rent" type="xs:string" minOccurs="0" maxOccurs="1"/>
      <xs:element name="administration" type="xs:string" minOccurs="0"
maxOccurs="1"/>
      <xs:element name="prospecting" type="xs:string" minOccurs="0"
maxOccurs="1"/>
    </xs:sequence>
  </xs:complexType>
</xs:element>

```

[top](#)

Element: **expenditures**

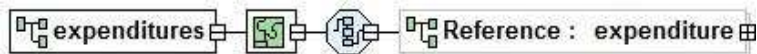
Name	expenditures
Type	Locally-defined complex type
Nullable	no
Abstract	no
Diagram	

XML Instance Representation

```
<expenditures>
  <expenditure> ... </expenditure> [0..*]
</expenditures>
```

Schema Component Representation

```
<xs:element name="expenditures">
  <xs:complexType>
    <xs:sequence>
      <xs:element ref="expenditure" minOccurs="0" maxOccurs="unbounded"/>
    </xs:sequence>
  </xs:complexType>
</xs:element>
```

[top](#)**Element: general**

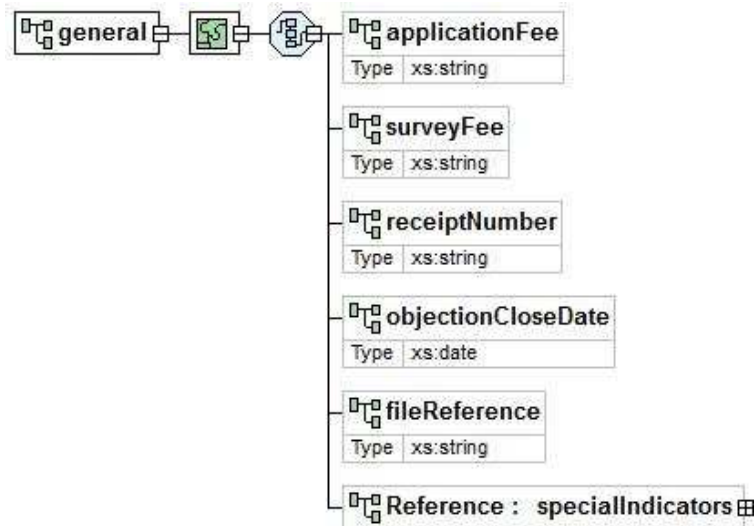
Name	general
Type	Locally-defined complex type
<u>Nilable</u>	no
<u>Abstract</u>	no
Diagram	

XML Instance Representation

```
<general>
  <applicationFee> xs:string </applicationFee> [0..1]
  <surveyFee> xs:string </surveyFee> [0..1]
  <receiptNumber> xs:string </receiptNumber> [0..1]
  <objectionCloseDate> xs:date </objectionCloseDate> [0..1]
  <fileReference> xs:string </fileReference> [0..1]
  <specialIndicators> ... </specialIndicators> [0..1]
</general>
```

Schema Component Representation

```
<xs:element name="general">
  <xs:complexType>
    <xs:sequence>
      <xs:element name="applicationFee" type="xs:string" minOccurs="0"
maxOccurs="1"/>
      <xs:element name="surveyFee" type="xs:string" minOccurs="0"
maxOccurs="1"/>
      <xs:element name="receiptNumber" type="xs:string" minOccurs="0"
maxOccurs="1"/>
      <xs:element name="objectionCloseDate" type="xs:date" minOccurs="0"
maxOccurs="1"/>
      <xs:element name="fileReference" type="xs:string" minOccurs="0"
maxOccurs="1"/>
      <xs:element name="specialIndicators" type="xs:string" minOccurs="0"
maxOccurs="1"/>
    </xs:sequence>
  </xs:complexType>
</xs:element>
```

```

maxOccurs="1"/>
<xs:element name="objectionCloseDate" type="xs:date" minOccurs="0"
maxOccurs="1"/>
<xs:element name="fileReference" type="xs:string" minOccurs="0"
maxOccurs="1"/>
<xs:element ref="specialIndicators" minOccurs="0" maxOccurs="1"/>
</xs:sequence>
</xs:complexType>
</xs:element>

```

[top](#)**Element: grant**

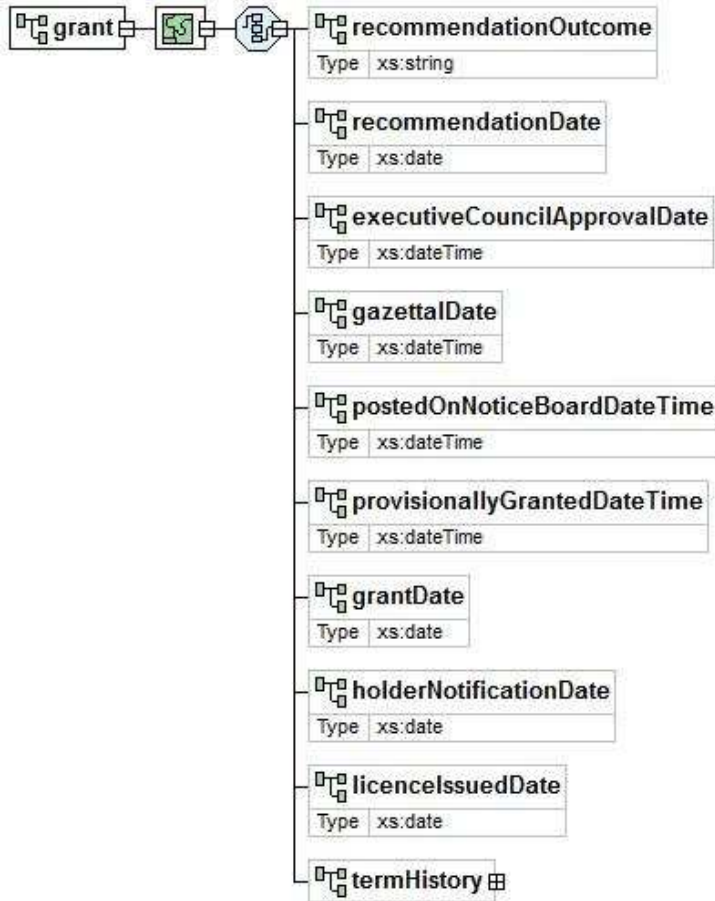
Name	grant
Type	Locally-defined complex type
<u>Nilable</u>	no
<u>Abstract</u>	no
Diagram	

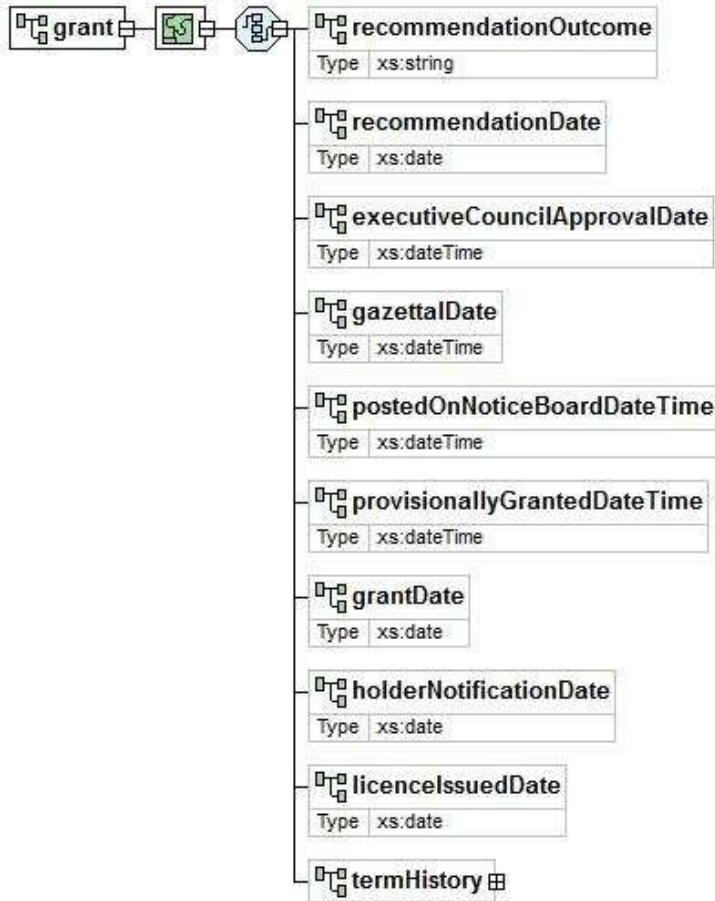
**XML Instance Representation**

```

<grant>
  <recommendationOutcome> xs:string </recommendationOutcome> [0..1]
  <recommendationDate> xs:date </recommendationDate> [0..1]
  <executiveCouncilApprovalDate> xs:dateTime </executiveCouncilApprovalDate>
  [0..1]
  <gazettalDate> xs:dateTime </gazettalDate> [0..1]
  <postedOnNoticeBoardDateTime> xs:dateTime </postedOnNoticeBoardDateTime>
  [0..1]
  <provisionallyGrantedDateTime> xs:dateTime </provisionallyGrantedDateTime>
  [0..1]
  <grantDate> xs:date </grantDate> [0..1]

```

```

<holderNotificationDate> xs:date </holderNotificationDate> [0..1]
<licenceIssuedDate> xs:date </licenceIssuedDate> [0..1]
<termHistory> [0..1]
  <term> ... </term> [0..*]
</termHistory>
</grant>

```

Schema Component Representation

```

<xs:element name="grant">
  <xs:complexType>
    <xs:sequence>
      <xs:element name="recommendationOutcome" type="xs:string"
        minOccurs="0" maxOccurs="1"/>
      <xs:element name="recommendationDate" type="xs:date" minOccurs="0"
        maxOccurs="1"/>
      <!-- executive council grant -->
      <xs:element name="executiveCouncilApprovalDate" type="xs:dateTime"
        minOccurs="0" maxOccurs="1"/>
      <xs:element name="gazettalDate" type="xs:dateTime" minOccurs="0"
        maxOccurs="1"/>
      <xs:element name="postedOnNoticeBoardDateTime" type="xs:dateTime"
        minOccurs="0" maxOccurs="1"/>
      <!-- executive council grant -->
      <!-- offshore minerals act -->
      <xs:element name="provisionallyGrantedDateTime" type="xs:dateTime"
        minOccurs="0" maxOccurs="1"/>
      <!-- offshore minerals act -->
      <xs:element name="grantDate" type="xs:date" minOccurs="0"
        maxOccurs="1"/>
      <xs:element name="holderNotificationDate" type="xs:date" minOccurs="0"
        maxOccurs="1"/>
      <xs:element name="licenceIssuedDate" type="xs:date" minOccurs="0"
        maxOccurs="1"/>
      <xs:element name="termHistory" minOccurs="0" maxOccurs="1">
        <xs:complexType>
          <xs:sequence>
            <xs:element ref="term" minOccurs="0" maxOccurs="unbounded"/>
          </xs:sequence>
        </xs:complexType>
      </xs:element>
    </xs:sequence>
  </xs:complexType>
</xs:element>

```

[top](#)

Element: **graticularArea**

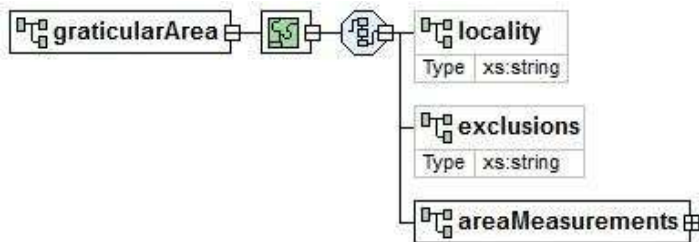
Name	graticularArea
Type	Locally-defined complex type
Niltable	no
Abstract	no
Diagram	

XML Instance Representation

```

<graticularArea>
  <locality> xs:string </locality> [0..1]
  <exclusions> xs:string </exclusions> [0..1]
  <areaMeasurements> [1]
    <areaMeasurement> ... </areaMeasurement> [0..*]
  </areaMeasurements>
</graticularArea>

```

Schema Component Representation

```

<xs:element name="graticularArea">
  <xs:complexType>
    <xs:sequence>
      <xs:element name="locality" type="xs:string" minOccurs="0"/>
      <xs:element name="exclusions" type="xs:string" minOccurs="0"/>
      <xs:element name="areaMeasurements" minOccurs="1" maxOccurs="1">
        <xs:complexType>
          <xs:sequence>
            <xs:element ref="areaMeasurement" minOccurs="0"
              maxOccurs="unbounded"/>
          </xs:sequence>
        </xs:complexType>
      </xs:element>
    </xs:sequence>
  </xs:complexType>
</xs:element>

```

[top](#)

Element: **holder**

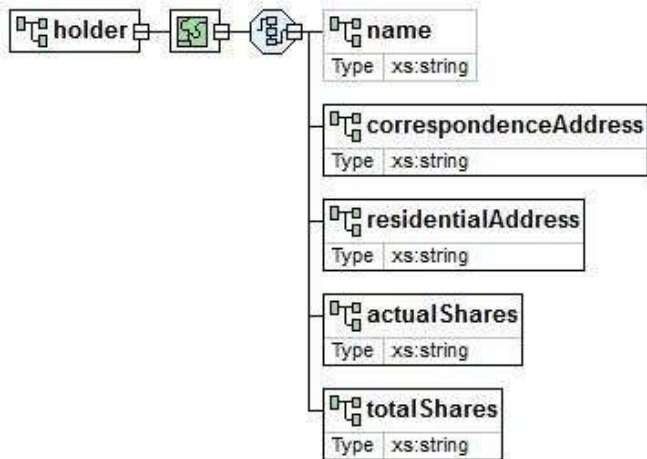
Name	holder
Type	Locally-defined complex type
Nilable	no
Abstract	no
Diagram	

XML Instance Representation

```

<holder>
  <name> xs:string </name> [0..1]
  <correspondenceAddress> xs:string </correspondenceAddress> [1]
  <residentialAddress> xs:string </residentialAddress> [1]
  <actualShares> xs:string </actualShares> [1]
  <totalShares> xs:string </totalShares> [1]
</holder>

```

Schema Component Representation

```

<xs:element name="holder">
  <xs:complexType>
    <xs:sequence>
      <xs:element name="name" type="xs:string" minOccurs="0"/>
      <xs:element name="correspondenceAddress" type="xs:string" minOccurs="1"
maxOccurs="1"/>
      <xs:element name="residentialAddress" type="xs:string" minOccurs="1"
maxOccurs="1"/>
      <xs:element name="actualShares" type="xs:string" minOccurs="1"
maxOccurs="1"/>
      <xs:element name="totalShares" type="xs:string" minOccurs="1"
maxOccurs="1"/>
    </xs:sequence>
  </xs:complexType>
</xs:element>

```

[top](#)

Element: holderChanges

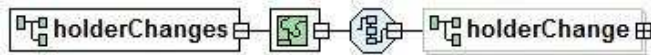
Name	holderChanges
Type	Locally-defined complex type
Nilable	no
Abstract	no
Diagram	

XML Instance Representation

```

<holderChanges>
  <holderChange> [0..*]
    <dealingType> xs:string </dealingType> [0..1]
    <dealingNumber> xs:string </dealingNumber> [0..1]
    <dealingStatus> xs:string </dealingStatus> [0..1]
    <fromHolder> xs:string </fromHolder> [0..1]
    <fromShares> xs:integer </fromShares> [0..1]
    <toHolder> xs:string </toHolder> [0..1]
    <toShares> xs:integer </toShares> [0..1]
  </holderChange>
</holderChanges>

```

Schema Component Representation

```

<xs:element name="holderChanges">
  <xs:complexType>
    <xs:sequence>
      <xs:element name="holderChange" minOccurs="0" maxOccurs="unbounded">
        <xs:complexType>
          <xs:sequence>
            <xs:element name="dealingType" type="xs:string" minOccurs="0"
maxOccurs="1"/>
            <xs:element name="dealingNumber" type="xs:string" minOccurs="0"
maxOccurs="1"/>
            <xs:element name="dealingStatus" type="xs:string" minOccurs="0"
maxOccurs="1"/>
            <xs:element name="fromHolder" type="xs:string" minOccurs="0"
maxOccurs="1"/>
            <xs:element name="fromShares" type="xs:integer" minOccurs="0"
maxOccurs="1"/>
            <xs:element name="toHolder" type="xs:string" minOccurs="0"
maxOccurs="1"/>
            <xs:element name="toShares" type="xs:integer" minOccurs="0"
maxOccurs="1"/>
          </xs:sequence>
        </xs:complexType>
      </xs:element>
    </xs:sequence>
  </xs:complexType>
</xs:element>

```

```

        </xs:element>
    </xs:sequence>
</xs:complexType>
</xs:element>

```

[top](#)**Element: holders**

Name	holders
Type	Locally-defined complex type
<u>Nilable</u>	no
<u>Abstract</u>	no
Diagram	

XML Instance Representation

```

<holders>
  <holder> ... </holder> [0..*]
</holders>

```

Schema Component Representation

```

<xs:element name="holders">
  <xs:complexType>
    <xs:sequence>
      <xs:element ref="holder" minOccurs="0" maxOccurs="unbounded"/>
    </xs:sequence>
  </xs:complexType>
</xs:element>

```

[top](#)**Element: latitude**

Name	latitude
Type	Locally-defined complex type
<u>Nilable</u>	no
<u>Abstract</u>	no
Diagram	

XML Instance Representation

```

<latitude>
  <centroidDetails> ... </centroidDetails> [1]
</latitude>

```

Schema Component Representation

```

<xs:element name="latitude">
  <xs:complexType>
    <xs:sequence>
      <xs:element ref="centroidDetails" minOccurs="1" maxOccurs="1"/>
    </xs:sequence>
  </xs:complexType>
</xs:element>

```

[top](#)

Element: longitude

Name	longitude
Type	Locally-defined complex type
Nilable	no
Abstract	no
Diagram	

XML Instance Representation

```
<longitude>
  <centroidDetails> ... </centroidDetails> [1]
</longitude>
```

Schema Component Representation

```
<xs:element name="longitude">
  <xs:complexType>
    <xs:sequence>
      <xs:element ref="centroidDetails" minOccurs="1" maxOccurs="1"/>
    </xs:sequence>
  </xs:complexType>
</xs:element>
```

[top](#)**Element: nativeTitle**

Name	nativeTitle
Type	Locally-defined complex type
Nilable	no
Abstract	no
Diagram	

XML Instance Representation

```
<nativeTitle>
  <nativeTitleLineItem> ... </nativeTitleLineItem> [0..*]
</nativeTitle>
```

Schema Component Representation

```
<xs:element name="nativeTitle">
  <xs:complexType>
    <xs:sequence>
      <xs:element ref="nativeTitleLineItem" minOccurs="0"
        maxOccurs="unbounded"/>
    </xs:sequence>
  </xs:complexType>
</xs:element>
```

[top](#)**Element: nativeTitleDetails**

Name	nativeTitleDetails
-------------	--------------------

Type	Locally-defined complex type
<u>Nilable</u>	no
<u>Abstract</u>	no
Diagram	

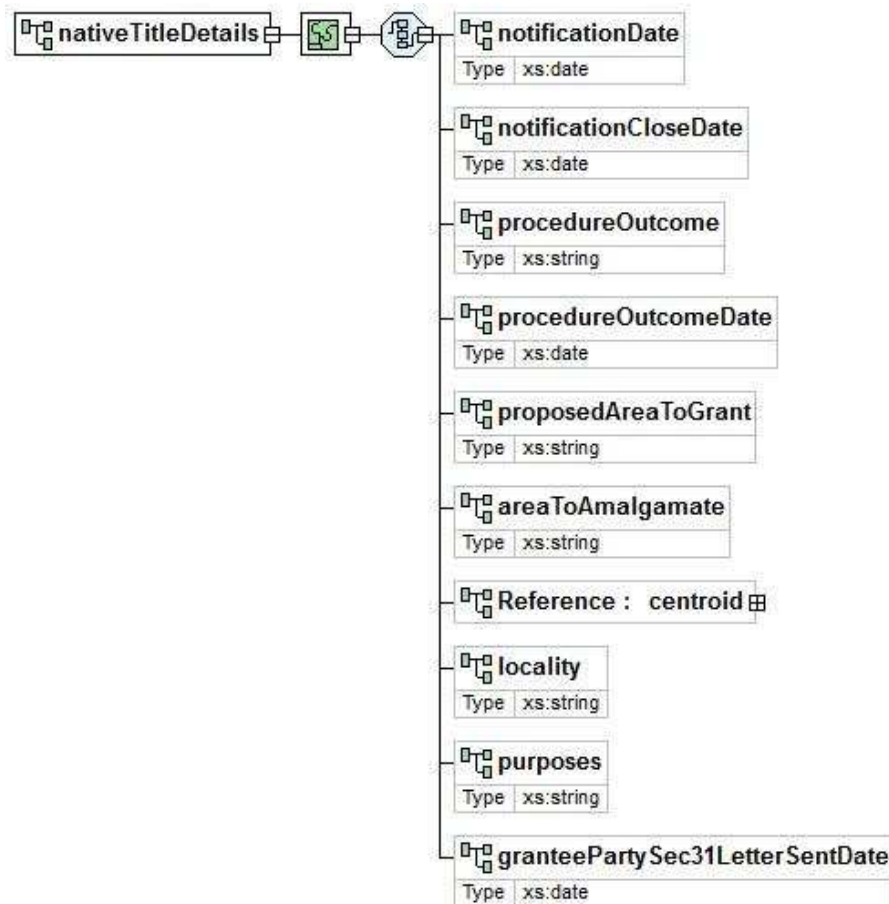

XML Instance Representation

```

<nativeTitleDetails>
  <notificationDate> xs:date </notificationDate> [0..1]
  <notificationCloseDate> xs:date </notificationCloseDate> [0..1]
  <procedureOutcome> xs:string </procedureOutcome> [0..1]
  <procedureOutcomeDate> xs:date </procedureOutcomeDate> [0..1]
  <proposedAreaToGrant> xs:string </proposedAreaToGrant> [0..1]
  <areaToAmalgamate> xs:string </areaToAmalgamate> [0..1]
  <centroid> ... </centroid> [0..1]
  <locality> xs:string </locality> [0..1]
  <purposes> xs:string </purposes> [0..1]
  <granteePartySec31LetterSentDate> xs:date
  </granteePartySec31LetterSentDate> [0..1]
</nativeTitleDetails>

```

Schema Component Representation

```

<xs:element name="nativeTitleDetails">
  <xs:complexType>
    <xs:sequence>
      <xs:element name="notificationDate" type="xs:date" minOccurs="0"
maxOccurs="1"/>
      <xs:element name="notificationCloseDate" type="xs:date" minOccurs="0"
maxOccurs="1"/>
      <xs:element name="procedureOutcome" type="xs:string" minOccurs="0"
maxOccurs="1"/>
      <xs:element name="procedureOutcomeDate" type="xs:date" minOccurs="0"
maxOccurs="1"/>
      <xs:element name="proposedAreaToGrant" type="xs:string" minOccurs="0"
maxOccurs="1"/>

```



```

<xs:element name="areaToAmalgamate" type="xs:string" minOccurs="0"
maxOccurs="1"/>
<xs:element ref="centroid" minOccurs="0" maxOccurs="1"/>
<xs:element name="locality" type="xs:string" minOccurs="0"
maxOccurs="1"/>
<xs:element name="purposes" type="xs:string" minOccurs="0"
maxOccurs="1"/>
<xs:element name="granteePartySec31LetterSentDate" type="xs:date"
minOccurs="0" maxOccurs="1"/>
</xs:sequence>
</xs:complexType>
</xs:element>

```

[top](#)

Element: nativeTitleLineItem

Name nativeTitleLineItem
Type Locally-defined complex type
Niltable no
Abstract no

Diagram

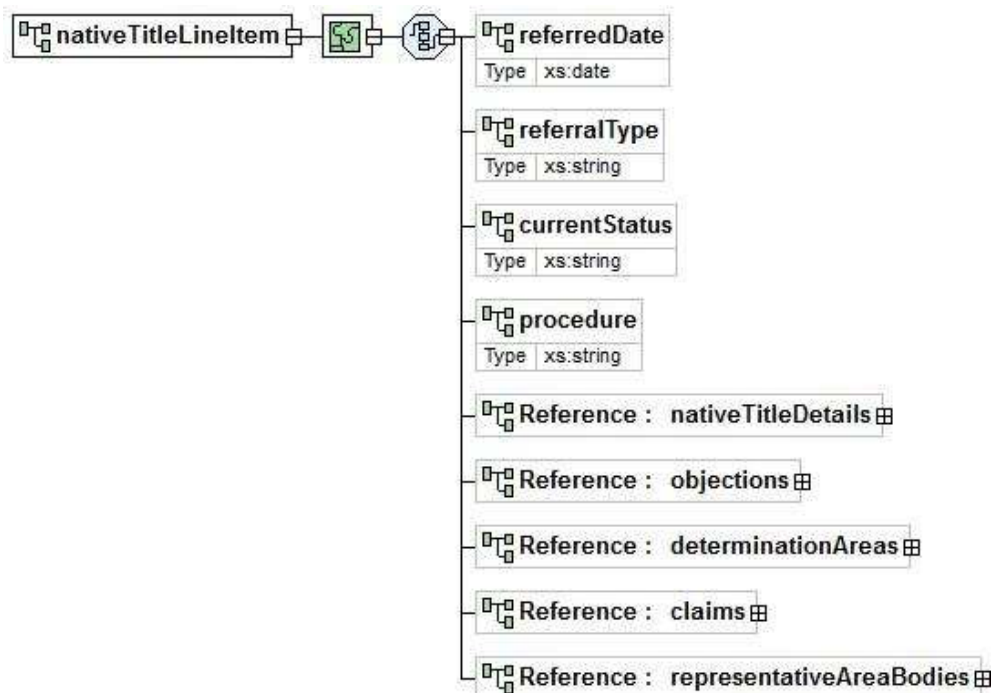

XML Instance Representation

```

<nativeTitleLineItem>
  <referredDate> xs:date </referredDate> [0..1]
  <referralType> xs:string </referralType> [0..1]
  <currentStatus> xs:string </currentStatus> [0..1]
  <procedure> xs:string </procedure> [0..1]
  <nativeTitleDetails> ... </nativeTitleDetails> [0..1]
  <objections> ... </objections> [0..1]
  <determinationAreas> ... </determinationAreas> [0..1]
  <claims> ... </claims> [0..1]
  <representativeAreaBodies> ... </representativeAreaBodies> [0..1]
</nativeTitleLineItem>

```

Schema Component Representation

```

<xs:element name="nativeTitleLineItem">
  <xs:complexType>

```

```

<xs:sequence>
  <xs:element name="referredDate" type="xs:date" minOccurs="0"
    maxOccurs="1"/>
  <xs:element name="referralType" type="xs:string" minOccurs="0"
    maxOccurs="1"/>
  <xs:element name="currentStatus" type="xs:string" minOccurs="0"
    maxOccurs="1"/>
  <xs:element name="procedure" type="xs:string" minOccurs="0"
    maxOccurs="1"/>
  <xs:element ref="nativeTitleDetails" minOccurs="0" maxOccurs="1"/>
  <xs:element ref="objections" minOccurs="0" maxOccurs="1"/>
  <xs:element ref="determinationAreas" minOccurs="0" maxOccurs="1"/>
  <xs:element ref="claims" minOccurs="0" maxOccurs="1"/>
  <xs:element ref="representativeAreaBodies" minOccurs="0"
    maxOccurs="1"/>
</xs:sequence>
</xs:complexType>
</xs:element>

```

[top](#)

Element: nonGraticularArea

Name	nonGraticularArea
Type	Locally-defined complex type
<u>Nilable</u>	no
<u>Abstract</u>	no
Diagram	

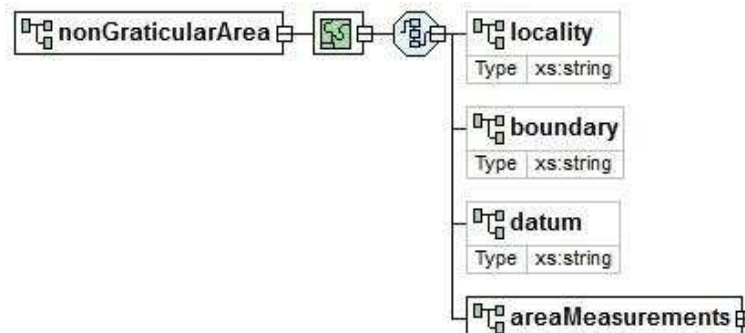

XML Instance Representation

```

<nonGraticularArea>
  <locality> xs:string </locality> [0..1]
  <boundary> xs:string </boundary> [0..1]
  <datum> xs:string </datum> [0..1]
  <areaMeasurements> [1]
    <areaMeasurement> ... </areaMeasurement> [0..*]
  </areaMeasurements>
</nonGraticularArea>

```

Schema Component Representation

```

<xs:element name="nonGraticularArea">
  <xs:complexType>
    <xs:sequence>
      <xs:element name="locality" type="xs:string" minOccurs="0"/>
      <xs:element name="boundary" type="xs:string" minOccurs="0"/>
      <xs:element name="datum" type="xs:string" minOccurs="0"
        maxOccurs="1"/>
      <xs:element name="areaMeasurements" minOccurs="1" maxOccurs="1">
        <xs:complexType>
          <xs:sequence>
            <xs:element ref="areaMeasurement" minOccurs="0"
              maxOccurs="unbounded"/>
          </xs:sequence>
        </xs:complexType>
      </xs:element>
    </xs:sequence>
  </xs:complexType>
</xs:element>

```

```

        </xs:sequence>
      </xs:complexType>
    </xs:element>
  </xs:sequence>
</xs:complexType>
</xs:element>

```

[top](#)**Element: objection**

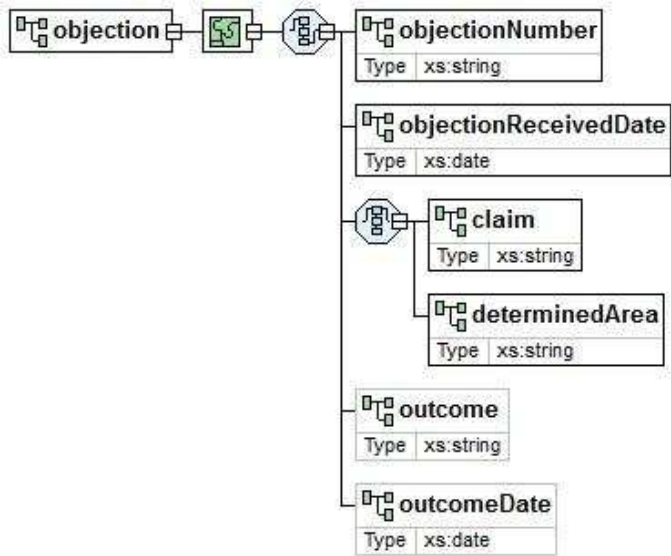
Name	objection
Type	Locally-defined complex type
Niltable	no
Abstract	no
Diagram	

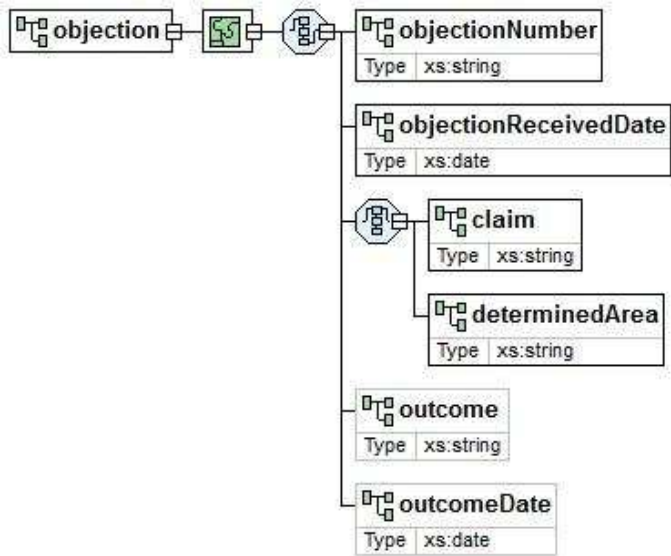
**XML Instance Representation**

```

<objection>
  <objectionNumber> xs:string </objectionNumber> [1]
  <objectionReceivedDate> xs:date </objectionReceivedDate> [1]
  Start Choice [1]
    <claim> xs:string </claim> [1]
    <determinedArea> xs:string </determinedArea> [1]
  End Choice
  <outcome> xs:string </outcome> [0..1]
  <outcomeDate> xs:date </outcomeDate> [0..1]
</objection>

```

Schema Component Representation

```

<xs:element name="objection">
  <xs:complexType>
    <xs:sequence>
      <xs:element name="objectionNumber" type="xs:string" minOccurs="1"
maxOccurs="1"/>
      <xs:element name="objectionReceivedDate" type="xs:date" minOccurs="1"
maxOccurs="1"/>
      <xs:choice minOccurs="1" maxOccurs="1">
        <xs:element name="claim" type="xs:string" />
        <xs:element name="determinedArea" type="xs:string" />
      </xs:choice>
      <xs:element name="outcome" type="xs:string" minOccurs="0"
maxOccurs="1"/>
      <xs:element name="outcomeDate" type="xs:date" minOccurs="0"

```

```

        maxOccurs="1"/>
    </xs:sequence>
</xs:complexType>
</xs:element>

```

[top](#)**Element: objections**

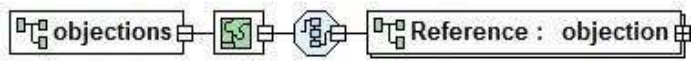
Name	objections
Type	Locally-defined complex type
<u>Nilable</u>	no
<u>Abstract</u>	no
Diagram	

XML Instance Representation

```

<objections>
  <objection> ... </objection> [1..*]
</objections>

```

Schema Component Representation

```

<xs:element name="objections">
  <xs:complexType>
    <xs:sequence>
      <xs:element ref="objection" minOccurs="1" maxOccurs="unbounded"/>
    </xs:sequence>
  </xs:complexType>
</xs:element>

```

[top](#)**Element: payments**

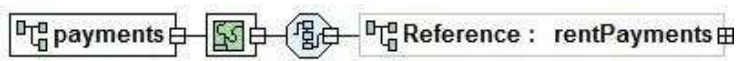
Name	payments
Type	Locally-defined complex type
<u>Nilable</u>	no
<u>Abstract</u>	no
Diagram	

XML Instance Representation

```

<payments>
  <rentPayments> ... </rentPayments> [0..1]
</payments>

```

Schema Component Representation

```

<xs:element name="payments">
  <xs:complexType>
    <xs:sequence>
      <xs:element ref="rentPayments" minOccurs="0" maxOccurs="1"/>
    </xs:sequence>
  </xs:complexType>
</xs:element>

```

[top](#)

Element: registerEntries

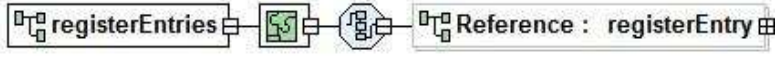
Name	registerEntries
Type	Locally-defined complex type
Nilable	no
Abstract	no
Diagram	

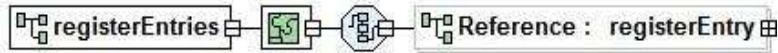
**XML Instance Representation**

```
<registerEntries>
  <registerEntry> ... </registerEntry> [0..*]
</registerEntries>
```

Schema Component Representation

```
<xs:element name="registerEntries">
  <xs:complexType>
    <xs:sequence>
      <xs:element ref="registerEntry" minOccurs="0" maxOccurs="unbounded"/>
    </xs:sequence>
  </xs:complexType>
</xs:element>
```

[top](#)**Element: registerEntry**

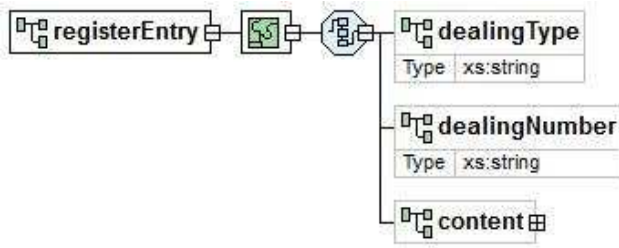
Name	registerEntry
Type	Locally-defined complex type
Nilable	no
Abstract	no
Diagram	

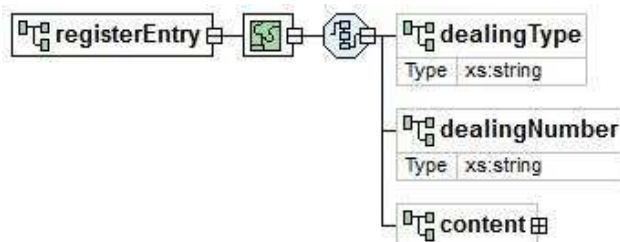
**XML Instance Representation**

```
<registerEntry>
  <dealingType> xs:string </dealingType> [0..1]
  <dealingNumber> xs:string </dealingNumber> [0..1]
  <content> [0..1]
    <lineItem> xs:string </lineItem> [1..*]
  </content>
</registerEntry>
```

Schema Component Representation

```
<xs:element name="registerEntry">
  <xs:complexType>
    <xs:sequence>
      <xs:element name="dealingType" type="xs:string" minOccurs="0"
        maxOccurs="1"/>
      <xs:element name="dealingNumber" type="xs:string" minOccurs="0"
        maxOccurs="1"/>
      <xs:element name="content" type="xs:complexType" minOccurs="0"
        maxOccurs="1"/>
    </xs:sequence>
  </xs:complexType>
</xs:element>
```

```

maxOccurs="1"/>
<xs:element name="content" minOccurs="0" maxOccurs="1">
  <xs:complexType>
    <xs:sequence>
      <xs:element name="lineItem" type="xs:string" minOccurs="1"
maxOccurs="unbounded"/>
    </xs:sequence>
  </xs:complexType>
</xs:element>
</xs:sequence>
</xs:complexType>
</xs:element>

```

[top](#)**Element: relationship**

Name	relationship
Type	Locally-defined complex type
Niltable	no
Abstract	no
Diagram	

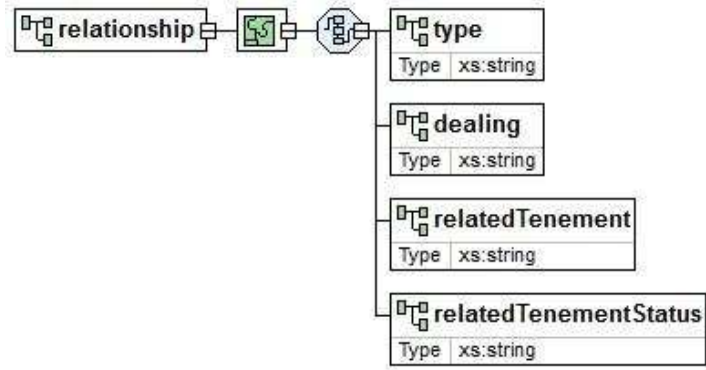
**XML Instance Representation**

```

<relationship>
  <type> xs:string </type> [1]
  <dealing> xs:string </dealing> [1]
  <relatedTenement> xs:string </relatedTenement> [1]
  <relatedTenementStatus> xs:string </relatedTenementStatus> [1]
</relationship>

```

Schema Component Representation

```

<xs:element name="relationship">
  <xs:complexType>
    <xs:sequence>
      <xs:element name="type" type="xs:string" minOccurs="1" maxOccurs="1"/>
      <xs:element name="dealing" type="xs:string" minOccurs="1"
maxOccurs="1"/>
      <xs:element name="relatedTenement" type="xs:string" minOccurs="1"
maxOccurs="1"/>
      <xs:element name="relatedTenementStatus" type="xs:string"
minOccurs="1" maxOccurs="1"/>
    </xs:sequence>
  </xs:complexType>
</xs:element>

```

[top](#)**Element: relationships**

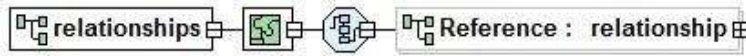
Name	relationships
Type	Locally-defined complex type
<u>Nilable</u>	no
<u>Abstract</u>	no
Diagram	

XML Instance Representation

```
<relationships>
  <relationship> ... </relationship> [0..*]
</relationships>
```

Schema Component Representation

```
<xs:element name="relationships">
  <xs:complexType>
    <xs:sequence>
      <xs:element ref="relationship" minOccurs="0" maxOccurs="unbounded"/>
    </xs:sequence>
  </xs:complexType>
</xs:element>
```

[top](#)**Element: rentPayment**

Name	rentPayment
Type	Locally-defined complex type
<u>Nilable</u>	no
<u>Abstract</u>	no
Diagram	

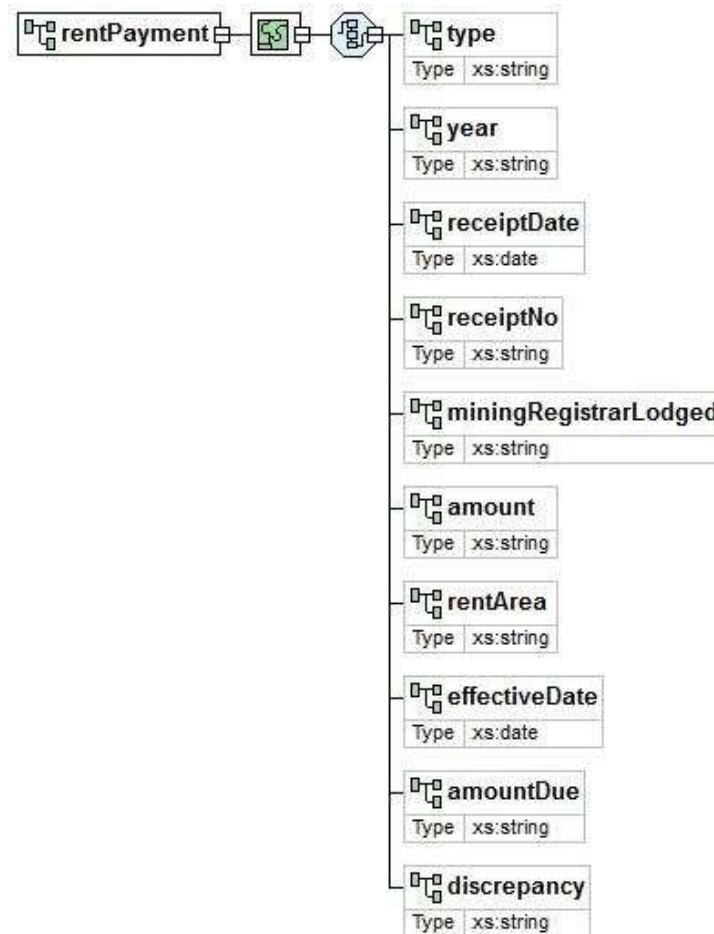

XML Instance Representation

```

<rentPayment>
  <type> xs:string </type> [0..1]
  <year> xs:string </year> [0..1]
  <receiptDate> xs:date </receiptDate> [0..1]
  <receiptNo> xs:string </receiptNo> [0..1]
  <miningRegistrarLodged> xs:string </miningRegistrarLodged> [0..1]
  <amount> xs:string </amount> [0..1]
  <rentArea> xs:string </rentArea> [0..1]
  <effectiveDate> xs:date </effectiveDate> [0..1]
  <amountDue> xs:string </amountDue> [0..1]
  <discrepancy> xs:string </discrepancy> [0..1]
</rentPayment>

```

Schema Component Representation

```

<xs:element name="rentPayment">
  <xs:complexType>
    <xs:sequence>
      <xs:element name="type" type="xs:string" minOccurs="0" maxOccurs="1"/>
      <xs:element name="year" type="xs:string" minOccurs="0" maxOccurs="1"/>
      <xs:element name="receiptDate" type="xs:date" minOccurs="0"
maxOccurs="1"/>
      <xs:element name="receiptNo" type="xs:string" minOccurs="0"
maxOccurs="1"/>
      <xs:element name="miningRegistrarLodged" type="xs:string"
minOccurs="0" maxOccurs="1"/>
      <xs:element name="amount" type="xs:string" minOccurs="0"
maxOccurs="1"/>
      <xs:element name="rentArea" type="xs:string" minOccurs="0"
maxOccurs="1"/>
      <xs:element name="effectiveDate" type="xs:date" minOccurs="0"
maxOccurs="1"/>

```



```

<xs:element name="amountDue" type="xs:string" minOccurs="0"
maxOccurs="1"/>
<xs:element name="discrepancy" type="xs:string" minOccurs="0"
maxOccurs="1"/>
</xs:sequence>
</xs:complexType>
</xs:element>

```

[top](#)**Element: rentPayments**

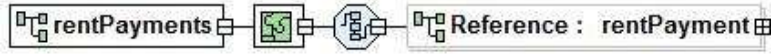
Name	rentPayments
Type	Locally-defined complex type
Nilable	no
Abstract	no
Diagram	

XML Instance Representation

```

<rentPayments>
  <rentPayment> ... </rentPayment> [0..*]
</rentPayments>

```

Schema Component Representation

```

<xs:element name="rentPayments">
  <xs:complexType>
    <xs:sequence>
      <xs:element ref="rentPayment" minOccurs="0" maxOccurs="unbounded"/>
    </xs:sequence>
  </xs:complexType>
</xs:element>

```

[top](#)**Element: representativeAreaBodies**

Name	representativeAreaBodies
Type	Locally-defined complex type
Nilable	no
Abstract	no
Diagram	

XML Instance Representation

```

<representativeAreaBodies>
  <representativeAreaBody> ... </representativeAreaBody> [0..*]
</representativeAreaBodies>

```

Schema Component Representation

```

<xs:element name="representativeAreaBodies">
  <xs:complexType>
    <xs:sequence>
      <xs:element ref="representativeAreaBody" minOccurs="0"
maxOccurs="unbounded"/>
    </xs:sequence>

```

```

</xs:complexType>
</xs:element>

```

[top](#)**Element: representativeAreaBody**

Name	representativeAreaBody
Type	Locally-defined complex type
Nilable	no
Abstract	no
Diagram	

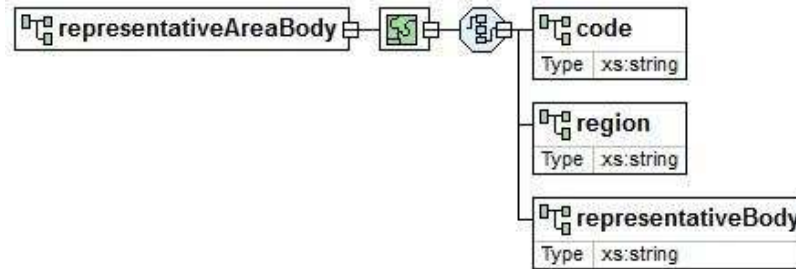
**XML Instance Representation**

```

<representativeAreaBody>
  <code> xs:string </code> [1]
  <region> xs:string </region> [1]
  <representativeBody> xs:string </representativeBody> [1]
</representativeAreaBody>

```

Schema Component Representation

```

<xs:element name="representativeAreaBody">
  <xs:complexType>
    <xs:sequence>
      <xs:element name="code" type="xs:string" minOccurs="1" maxOccurs="1"/>
      <xs:element name="region" type="xs:string" minOccurs="1"
maxOccurs="1"/>
      <xs:element name="representativeBody" type="xs:string" minOccurs="1"
maxOccurs="1"/>
    </xs:sequence>
  </xs:complexType>
</xs:element>

```

[top](#)**Element: shire**

Name	shire
Type	Locally-defined complex type
Nilable	no
Abstract	no
Diagram	

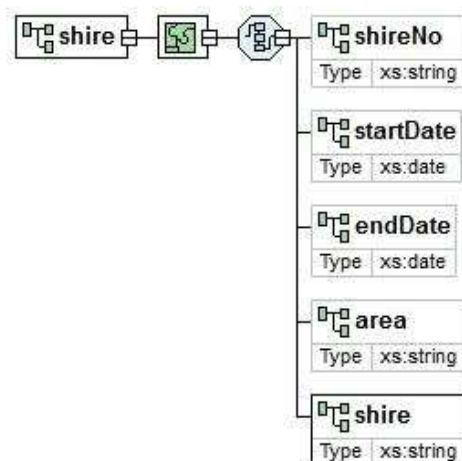

XML Instance Representation

```

<shire>
  <shireNo> xs:string </shireNo> [0..1]
  <startDate> xs:date </startDate> [0..1]
  <endDate> xs:date </endDate> [0..1]
  <area> xs:string </area> [0..1]
  <shire> xs:string </shire> [1]
</shire>

```

Schema Component Representation

```

<xs:element name="shire">
  <xs:complexType>
    <xs:sequence>
      <xs:element name="shireNo" type="xs:string" minOccurs="0"/>
      <xs:element name="startDate" type="xs:date" minOccurs="0"/>
      <xs:element name="endDate" type="xs:date" minOccurs="0"
maxOccurs="1"/>
      <xs:element name="area" type="xs:string" minOccurs="0"/>
      <xs:element name="shire" type="xs:string" />
    </xs:sequence>
  </xs:complexType>
</xs:element>

```

[top](#)

Element: shires

Name	shires
Type	Locally-defined complex type
Niltable	no
Abstract	no
Diagram	<pre> graph LR shires[shires] --- seq[Sequence] seq --- shire[Reference : shire] </pre>

XML Instance Representation

```

<shires>
  <shire> ... </shire> [0..*]
</shires>

```

Schema Component Representation

```

<xs:element name="shires">
  <xs:complexType>
    <xs:sequence>

```

```

        <xs:element ref="shire" minOccurs="0" maxOccurs="unbounded"/>
    </xs:sequence>
</xs:complexType>
</xs:element>

```

[top](#)**Element: specialIndicators**

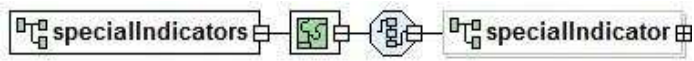
Name	specialIndicators
Type	Locally-defined complex type
<u>Nilable</u>	no
<u>Abstract</u>	no
Diagram	

XML Instance Representation

```

<specialIndicators>
  <specialIndicator> [0..*]
    <specialIndicator> xs:string </specialIndicator> [1]
    <specialIndicatorStartDate> xs:date </specialIndicatorStartDate> [1]
    <specialIndicatorEndDate> xs:date </specialIndicatorEndDate> [0..1]
  </specialIndicator>
</specialIndicators>

```

Schema Component Representation

```

<xs:element name="specialIndicators">
  <xs:complexType>
    <xs:sequence>
      <xs:element name="specialIndicator" minOccurs="0"
        maxOccurs="unbounded">
        <xs:complexType>
          <xs:sequence>
            <xs:element name="specialIndicator" type="xs:string"
              minOccurs="1" maxOccurs="1"/>
            <xs:element name="specialIndicatorStartDate" type="xs:date"
              minOccurs="1" maxOccurs="1"/>
            <xs:element name="specialIndicatorEndDate" type="xs:date"
              minOccurs="0" maxOccurs="1"/>
          </xs:sequence>
        </xs:complexType>
      </xs:element>
    </xs:sequence>
  </xs:complexType>
</xs:element>

```

[top](#)**Element: survey**

Name	survey
Type	Locally-defined complex type
<u>Nilable</u>	no
<u>Abstract</u>	no
Diagram	

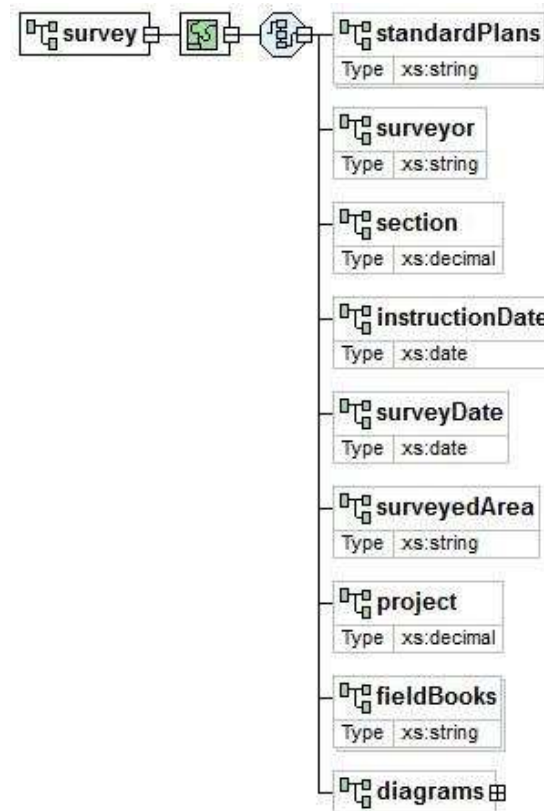

XML Instance Representation

```

<survey>
  <standardPlans> xs:string </standardPlans> [0..*]
  <surveyor> xs:string </surveyor> [0..1]
  <section> xs:decimal </section> [0..1]
  <instructionDate> xs:date </instructionDate> [0..1]
  <surveyDate> xs:date </surveyDate> [0..1]
  <surveyedArea> xs:string </surveyedArea> [0..1]
  <project> xs:decimal </project> [0..1]
  <fieldBooks> xs:string </fieldBooks> [0..*]
  <diagrams> [0..1]
    <diagram> [0..*]
      <documentNumber> xs:string </documentNumber> [0..1]
      <documentType> xs:string </documentType> [0..1]
    </diagram>
  </diagrams>
</survey>

```

Schema Component Representation

```

<xs:element name="survey">
  <xs:complexType>
    <xs:sequence>
      <xs:element name="standardPlans" type="xs:string" minOccurs="0"
maxOccurs="unbounded"/>
      <xs:element name="surveyor" type="xs:string" minOccurs="0"/>
      <xs:element name="section" type="xs:decimal" minOccurs="0"/>
      <xs:element name="instructionDate" type="xs:date" minOccurs="0"/>
      <xs:element name="surveyDate" type="xs:date" minOccurs="0"/>
      <xs:element name="surveyedArea" type="xs:string" minOccurs="0"
maxOccurs="1"/>
      <xs:element name="project" type="xs:decimal" minOccurs="0"
maxOccurs="1"/>
      <xs:element name="fieldBooks" type="xs:string" minOccurs="0"
maxOccurs="unbounded"/>
      <xs:element name="diagrams" minOccurs="0" maxOccurs="1">
        <xs:complexType>
          <xs:sequence>

```

```

    <xs:element name="diagram" minOccurs="0" maxOccurs="unbounded">
      <xs:complexType>
        <xs:sequence>
          <xs:element name="documentNumber" type="xs:string"
            minOccurs="0"/>
          <xs:element name="documentType" type="xs:string"
            minOccurs="0"/>
        </xs:sequence>
      </xs:complexType>
    </xs:element>
  </xs:sequence>
</xs:complexType>
</xs:element>

```

[top](#)**Element: surveys**

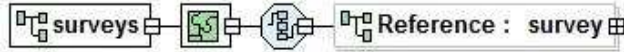
Name	surveys
Type	Locally-defined complex type
<u>Nilable</u>	no
<u>Abstract</u>	no
Diagram	

XML Instance Representation

```

<surveys>
  <survey> ... </survey> [0..*]
</surveys>

```

Schema Component Representation

```

<xs:element name="surveys">
  <xs:complexType>
    <xs:sequence>
      <xs:element ref="survey" minOccurs="0" maxOccurs="unbounded"/>
    </xs:sequence>
  </xs:complexType>
</xs:element>

```

[top](#)**Element: tenement**

Name	tenement
Type	Locally-defined complex type
<u>Nilable</u>	no
<u>Abstract</u>	no
Diagram	

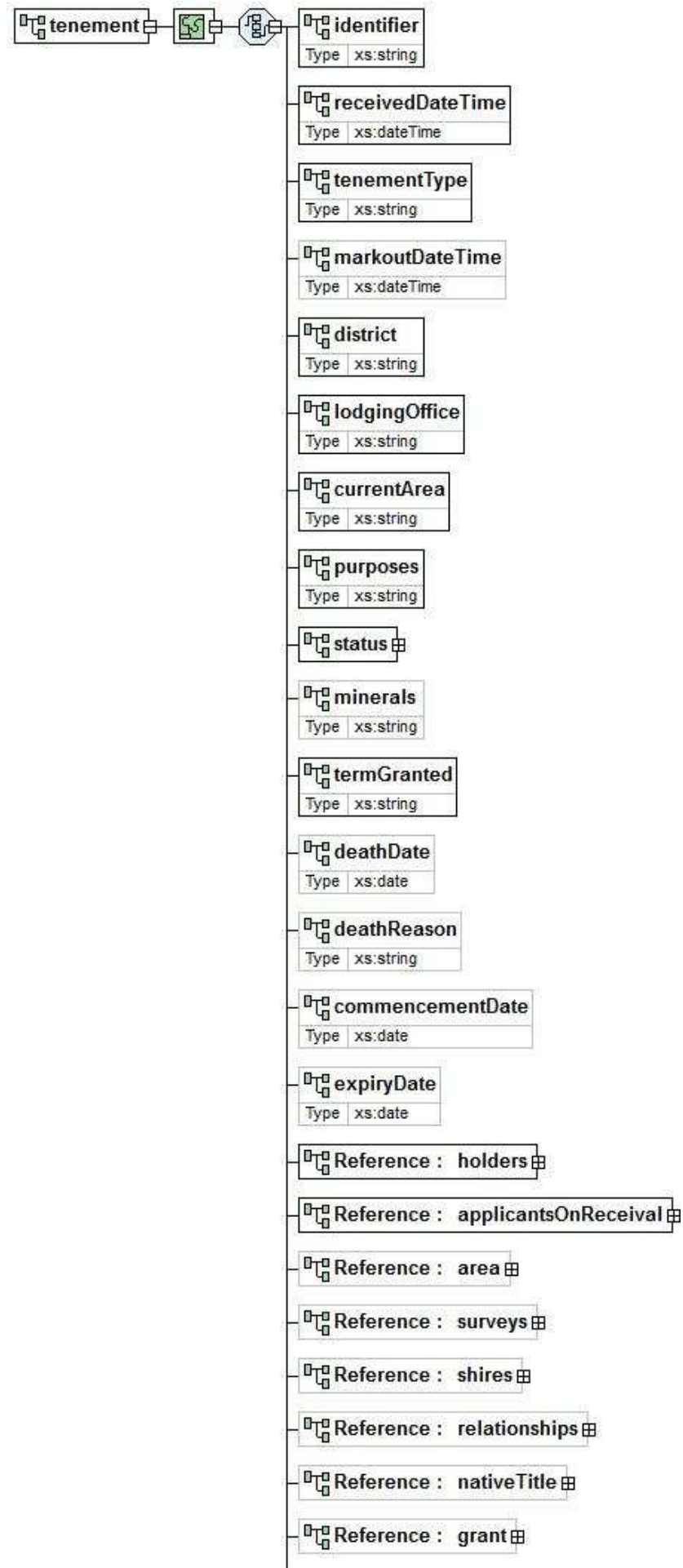

XML Instance Representation

```

<tenement>
  <identifier> xs:string </identifier> [1]
  <receivedDateTime> xs:dateTime </receivedDateTime> [1]
  <tenementType> xs:string </tenementType> [1]
  <markoutDateTime> xs:dateTime </markoutDateTime> [0..1]
  <district> xs:string </district> [1]
  <lodgingOffice> xs:string </lodgingOffice> [1]
  <currentArea> xs:string </currentArea> [1]
  <purposes> xs:string </purposes> [1]
  <status> xs:string (value comes from list: {'Dead'|'Live'|'Pending'})
</status> [1]
  <minerals> xs:string </minerals> [0..1]
  <termGranted> xs:string </termGranted> [1]
  <deathDate> xs:date </deathDate> [0..1]
  <deathReason> xs:string </deathReason> [0..1]
  <commencementDate> xs:date </commencementDate> [0..1]
  <expiryDate> xs:date </expiryDate> [0..1]
  <holders> ... </holders> [1]
  <applicantsOnReceival> ... </applicantsOnReceival> [1]
  <area> ... </area> [0..1]
  <surveys> ... </surveys> [0..1]
  <shires> ... </shires> [0..1]
  <relationships> ... </relationships> [0..1]
  <nativeTitle> ... </nativeTitle> [0..1]
  <grant> ... </grant> [0..1]
  <conditions> ... </conditions> [0..1]
  <endorsements> ... </endorsements> [0..1]
  <general> ... </general> [0..1]
  <expenditures> ... </expenditures> [0..1]
  <payments> ... </payments> [0..1]
  <combinedReporting> ... </combinedReporting> [0..1]
  <registerEntries> ... </registerEntries> [0..1]
  <holderChanges> ... </holderChanges> [0..1]
  <bonds> ... </bonds> [0..1]
</tenement>

```

Schema Component Representation

```

<xs:element name="tenement">
  <xs:complexType>
    <xs:sequence>
      <!-- summary -->
      <xs:element name="identifier" type="xs:string" minOccurs="1"
maxOccurs="1"/>
      <xs:element name="receivedDateTime" type="xs:dateTime" minOccurs="1"
maxOccurs="1"/>
      <xs:element name="tenementType" type="xs:string" minOccurs="1"
maxOccurs="1"/>
      <xs:element name="markoutDateTime" type="xs:dateTime" minOccurs="0"
maxOccurs="1"/>
      <xs:element name="district" type="xs:string" maxOccurs="1"
minOccurs="1"/>
      <xs:element name="lodgingOffice" type="xs:string" maxOccurs="1"
minOccurs="1"/>
      <xs:element name="currentArea" type="xs:string" maxOccurs="1"
minOccurs="1"/>
      <xs:element name="purposes" type="xs:string" maxOccurs="1"
minOccurs="1"/>
      <xs:element name="status" minOccurs="1" maxOccurs="1">
        <xs:simpleType>
          <xs:restriction base="xs:string">
            <xs:enumeration value="Dead"/>
            <xs:enumeration value="Live"/>
            <xs:enumeration value="Pending"/>
          </xs:restriction>
        </xs:simpleType>
      </xs:element>
      <xs:element name="minerals" type="xs:string" minOccurs="0"

```



```

maxOccurs="1"/>
<xs:element name="termGranted" type="xs:string" minOccurs="1"
maxOccurs="1"/>
<xs:element name="deathDate" type="xs:date" minOccurs="0"
maxOccurs="1"/>
<xs:element name="deathReason" type="xs:string" minOccurs="0"
maxOccurs="1"/>
<xs:element name="commencementDate" type="xs:date" minOccurs="0"
maxOccurs="1"/>
<xs:element name="expiryDate" type="xs:date" minOccurs="0"
maxOccurs="1"/>
<xs:element ref="holders" minOccurs="1" maxOccurs="1"/>
<xs:element ref="applicantsOnReceival" minOccurs="1" maxOccurs="1"/>
<-- End Summary -->
<-- Description -->
<xs:element ref="area" minOccurs="0" maxOccurs="1"/>
<xs:element ref="surveys" minOccurs="0" maxOccurs="1"/>
<xs:element ref="shires" minOccurs="0" maxOccurs="1"/>
<xs:element ref="relationships" minOccurs="0" maxOccurs="1"/>
<-- End Description -->
<-- Determination -->
<xs:element ref="nativeTitle" minOccurs="0" maxOccurs="1"/>
<xs:element ref="grant" minOccurs="0" maxOccurs="1"/>
<xs:element ref="conditions" minOccurs="0" maxOccurs="1"/>
<xs:element ref="endorsements" minOccurs="0" maxOccurs="1"/>
<-- End Determination -->
<-- General -->
<xs:element ref="general" minOccurs="0" maxOccurs="1"/>
<-- End General -->
<-- Compliance -->
<xs:element ref="expenditures" minOccurs="0" maxOccurs="1"/>
<xs:element ref="payments" minOccurs="0" maxOccurs="1"/>
<xs:element ref="combinedReporting" minOccurs="0" maxOccurs="1"/>
<-- End Compliance -->
<-- Dealings -->
<xs:element ref="registerEntries" minOccurs="0" maxOccurs="1"/>
<xs:element ref="holderChanges" minOccurs="0" maxOccurs="1"/>
<xs:element ref="bonds" minOccurs="0" maxOccurs="1"/>
<-- End Dealings -->
</xs:sequence>
</xs:complexType>
</xs:element>

```

[top](#)**Element: tenements**

Name	tenements
Type	Locally-defined complex type
Niltable	no
Abstract	no

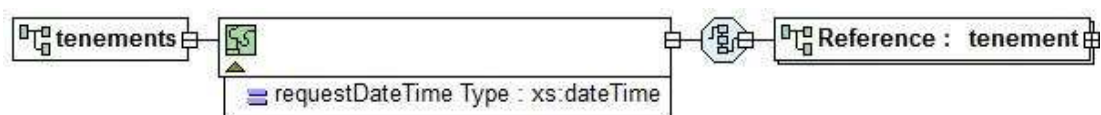
Diagram**XML Instance Representation**

```

<tenements
  requestDateTime="xs:dateTime [1]">
  <tenement> ... </tenement> [1..*]
</tenements>

```

Schema Component Representation

```

<xs:element name="tenements">
  <xs:complexType>
    <xs:sequence>
      <xs:element ref="tenement" minOccurs="1" maxOccurs="unbounded"/>
    </xs:sequence>
    <xs:attribute name="requestDateTime" type="xs:dateTime" use="required"/>
  </xs:complexType>
</xs:element>

```

[top](#)**Element: term**

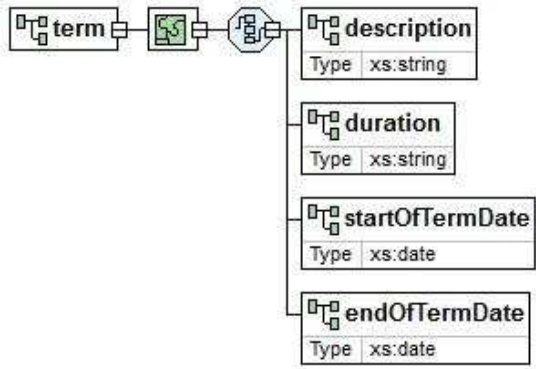
Name	term
Type	Locally-defined complex type
Nilable	no
Abstract	no
Diagram	

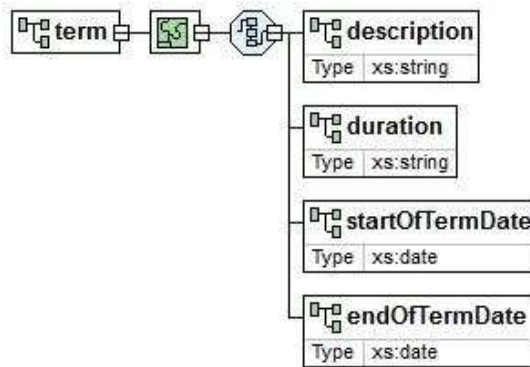
**XML Instance Representation**

```

<term>
  <description> xs:string </description> [1]
  <duration> xs:string </duration> [1]
  <startOfTermDate> xs:date </startOfTermDate> [1]
  <endOfTermDate> xs:date </endOfTermDate> [1]
</term>

```

Schema Component Representation

```

<xs:element name="term">
  <xs:complexType>
    <xs:sequence>
      <xs:element name="description" type="xs:string" minOccurs="1"
        maxOccurs="1"/>
      <xs:element name="duration" type="xs:string" minOccurs="1"
        maxOccurs="1"/>
      <xs:element name="startOfTermDate" type="xs:date" minOccurs="1"
        maxOccurs="1"/>
      <xs:element name="endOfTermDate" type="xs:date" minOccurs="1"
        maxOccurs="1"/>
    </xs:sequence>
  </xs:complexType>
</xs:element>

```

[top](#)